

CONTENITORE C125

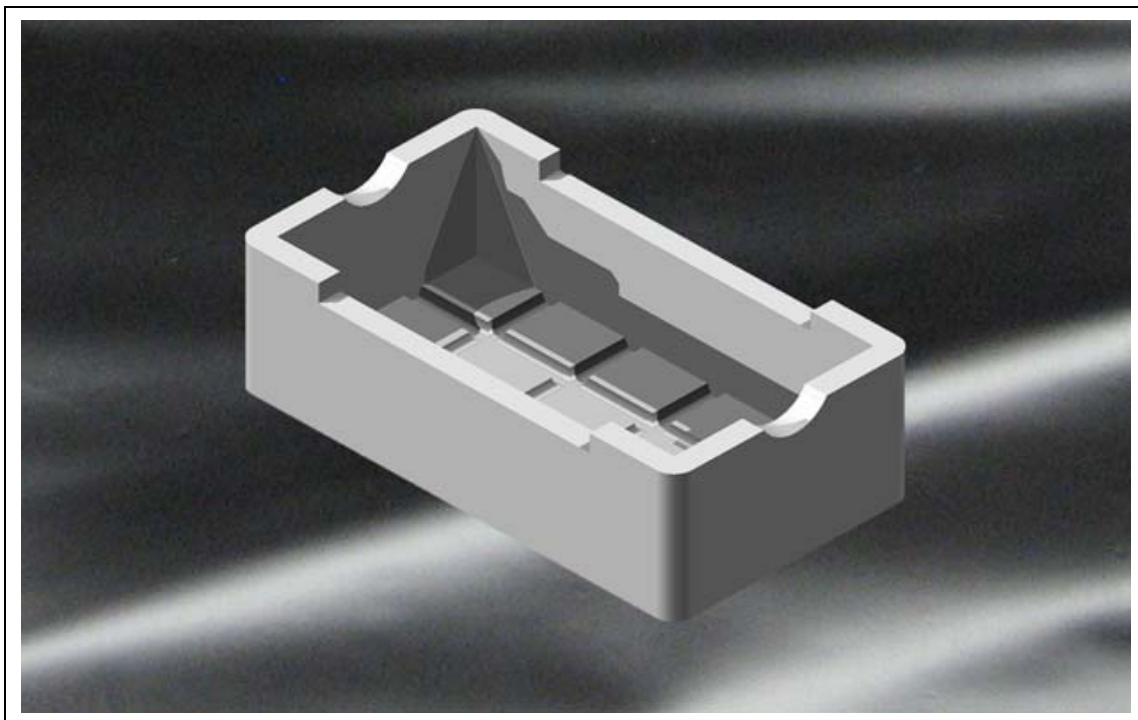

DESCRIZIONE ARTICOLO

Contenitore termico per alimenti caseari

MATERIALE

Polistirolo Espanso Sinterizzato EPS bianco

DIMENSIONI ESTERNE:

245 x 135 H78 mm

CAPACITA':

1,6litri

LE MATERIE PRIME UTILIZZATE SONO IDONEE AL CONTATTO CON ALIMENTI

